

STANDARD EXTRUSIONS

43mm CHANNEL 43 x 20 x 1.5mm Aluminium U-Channel, Drilled and Countersunk

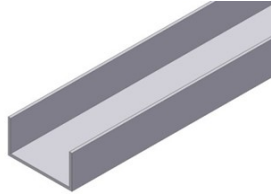
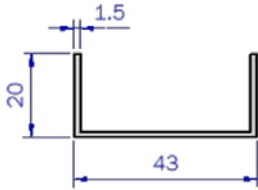

Item Code	Colours	Code	Length	Pack Qty
FE-43C	Mill Finish Natural Anodised White PC Pottery PC	MF NA WH PT	6.0m	10

38mm CHANNEL 38 x 20 x 1.5mm Aluminium U-Channel, Drilled and Countersunk

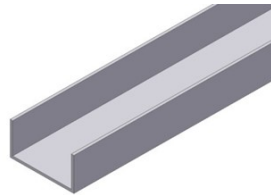
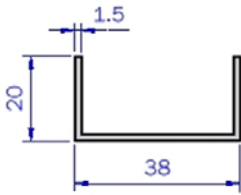

Item Code	Colours	Code	Length	Pack Qty
FE-38C	Mill Finish Natural Anodised White PC Pottery PC	MF NA WH PT	6.0m	10

PELMET 30 x 20 x 26mm Aluminium Pelmet, Drilled and Countersunk

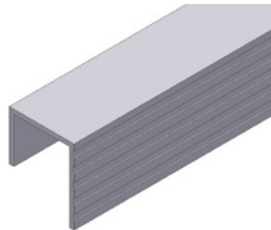
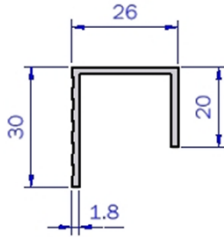

Item Code	Colours	Code	Length	Pack Qty
FE-PEL	Mill Finish Natural Anodised	MF NA	6.0m	10

T-SECTION 25 x 25 x 2.5mm Aluminium T-Section Drilled and Countersunk

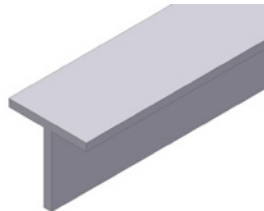
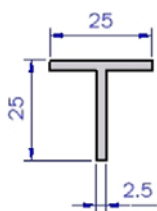

Item Code	Colours	Code	Length	Pack Qty
FE-25T	Mill Finish Natural Anodised	MF NA	6.0m	10

BOTTOM TRACK Bottom Track Drilled and Countersunk

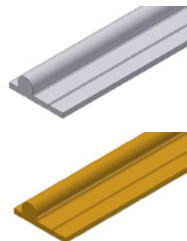
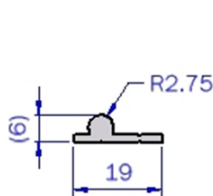

Item Code	Colours	Code	Length	Pack Qty
FE-BT	Mill Finish Natural Anodised	MF NA	6.0m	10
FE-BBT	Solid Brass	Brass	4.8m	10

HEAVY DUTY BOTTOM TRACK Heavy Duty Bottom Track Drilled and Countersunk

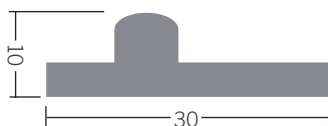

Item Code	Colours	Code	Length	Pack Qty
FE-HDBT	Natural Anodised	NA	5.3m	10

PLEASE NOTE: Special colours are available upon request.

ADDITIONAL EXTRUSIONS

ADJUSTABLE CHANNEL

Adjustable Aluminium Channel, Lipped

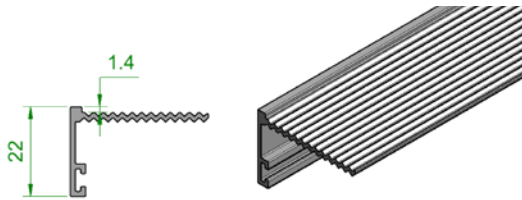

Item Code	Colours	Code	Length	Pack Qty
FE-ADJL	Mill Finish Natural Anodised	MF NA	6.0m	10

Adjustable Aluminium Channel, Non-Lipped

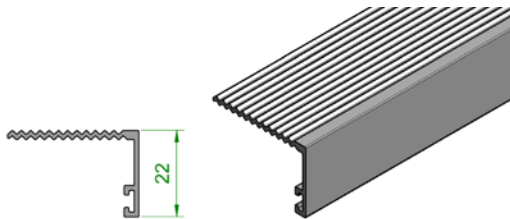

Item Code	Colours	Code	Length	Pack Qty
FE-ADJ	Mill Finish Natural Anodised	MF NA	6.0m	10

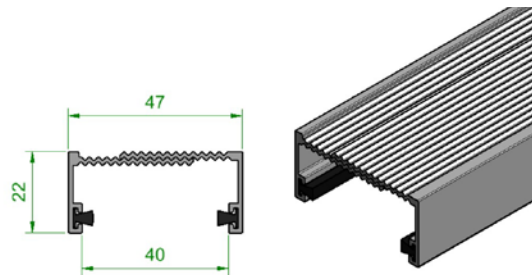
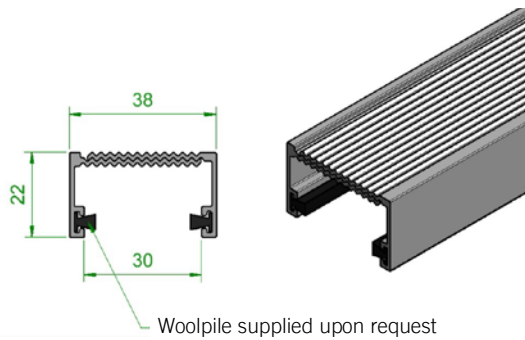

INTERLOCKER

Aluminium Interlock with Woolpile inserted (upon request)

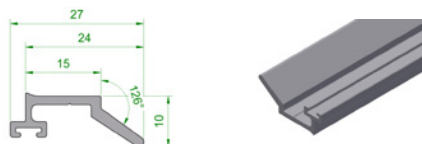

Item Code	Colours	Code	Length	Pack Qty
FE-INTR	Natural Anodised	NA	4.8m	10
FE-INTR	Black	BK	4.8m	10

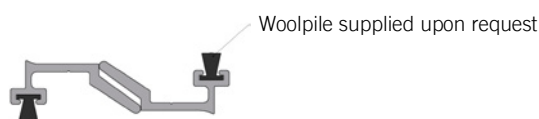

PLEASE NOTE: Special colours are available upon request.